

## Festoon Lights 240v 10m 15 Bulbs 1W/15W (240FEST-15) FOR INDOOR AND OUTDOOR USE

These 240V LED festoon lights are available in Warm White, Ice White, Clear and Multicoloured on a rubber black and white cable. Each string is 10m long with 15 replaceable bulbs which you connect together to create your required length.

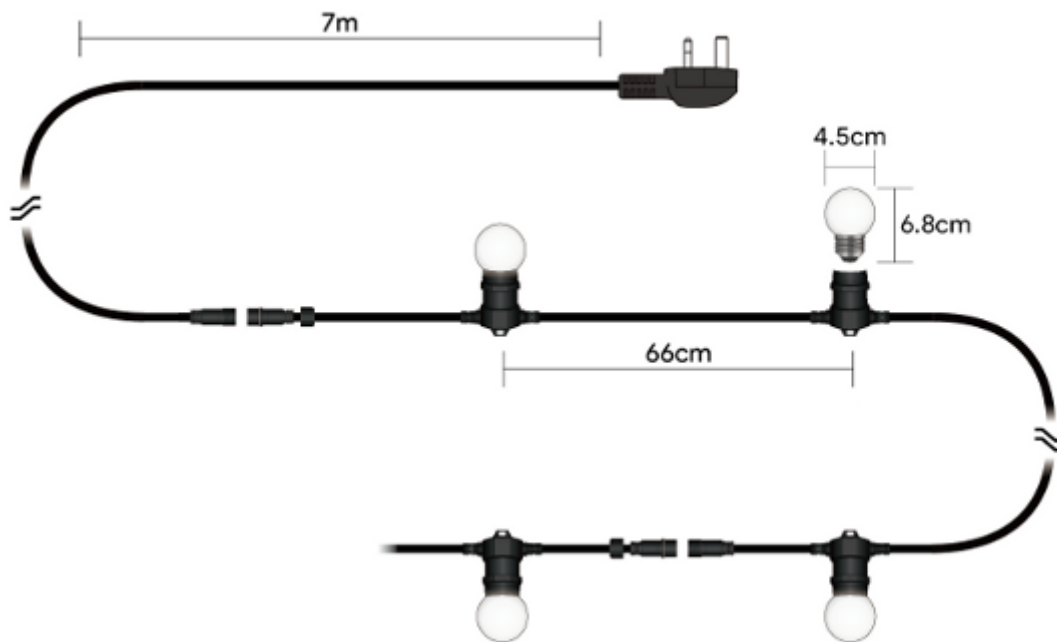

### Connection Instructions

This is a modular, interconnectable lighting system, designed for indoor and outdoor use. The light set is IP44 rated with rubber cable

**IMPORTANT NOTE:** - You can connect up to 200m (300 bulbs) from one plug or alternatively you can use a Y- splitter to connect up to 300m (450 bulbs) from one plug.

Splitters and extensions are also compatible with these (see the **"Festoon Lights Accessories Range"** section overleaf).

1. If your plug is not connected to a set of lights, connect the plug to the first string of lights by pushing the male/female connectors together.
2. When connecting power cords, lights or accessories, it's important to make a good seal to ensure a waterproof connection. This is achieved by pushing the male and female connectors as tightly as possible ensuring that the rubber 'O-ring' is compressed to make the seal. Please note if the seal is not made correctly and water gets in your warranty will be invalid.

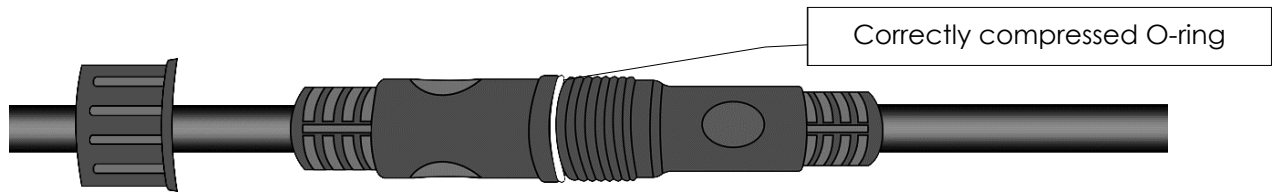

3. The cap can then be screwed into place. There will be a cap provided for the end of the lights, please note – this must also be screwed into place to seal the final string of lights.

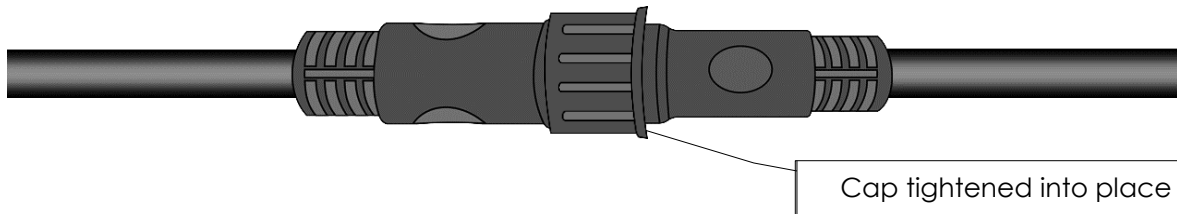

4. Test the lights by plugging them in before you install them.

## Warnings





1. The external, flexible cable or cord of this light set cannot be replaced; if the cord is damaged, the set should be safely disposed of. The lamps are not replaceable.
2. The Transformer plug must be positioned indoors or in a waterproof socket at all times.
3. Do NOT overload. Connect other lighting chains of the same type up to a maximum of 70 metres in a single run or 140m using a y-splitter.
4. **Installing** – The Light string must be supported every 5m, preferably at the connectors if you are extending. Do not hang loose over this length as damage could be caused to the wire connections.
5. When replacing spare bulbs it's important you screw the bulb as tightly as possible to make a waterproof seal. If the bulbs are not screwed tightly, water will get in and they will become damaged.

## Troubleshooting

If for any reason when you first plug the lights in they do not work please try the following and if none of these resolve the issue, please contact us:

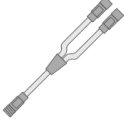
1. Is the connector pushed fully together to make a connection?
2. If you have multiple strings connected together and the lights do not seem to be working, please disconnect them all and try connecting each set on its own with the power cord to identify which string is not illuminating.
3. If you have connected your set together, but it fails to light, it may be a polarity issue. Very occasionally the guide notch on the connectors can be placed upside down during manufacturing. You can work around this by simply disconnecting, rotating one connector 180 degrees, and pushing the connectors together - irrespective of the guide notch's position. You may find some resistance but this is normal. **This will not affect the operation of your lights.**

## Festoon Lights Accessories

<p><b>Blank Extension Cable (10 metre) - Product Code: XTO240FEST</b></p> <p>Extension cables are available in 10 metres. Great for adding after your power cord to get from your socket to where your lights start outside. These extension cables can be used anywhere in your display, either after your power cord or in between the light sets to give you extra cabling if required.</p>	
	<p><b>2 way splitters – Product Code: 240FESTY</b></p> <p>If you order more than 200m, a splitter will be supplied as standard. Splitters are the key to lighting many sections of a display neatly, without the need for additional power sources. Use splitters at any point in your light sections to branch off in different directions.</p>
<p><b>Spare Bulbs Golf Ball – Product Code SB240</b></p> <p>If you need to replace any bulbs or want to change the colour of your lights, then we have spare bulbs available in all colours to purchase online.</p>	
	<p><b>Spare Bulbs Clear Drop Bulbs – Product Code SBHANGFEST</b></p> <p>You can change the look of your display by using our hanging bulb festoons in your existing harness as both the golf ball and drop bulbs will work. These are available in warm white and you can choose from a plastic or glass option.</p>
<p><b>Power cord - If you need to adapt your display – Product Code: PCO240FEST</b></p> <p>If you need another plug transformer to light up your Festoon display in a different area or replace your existing plug, you can purchase one online using the code above.</p>	

For Full Instructions, technical information and diagrams, please refer to our websites

[www.xmasdirect.co.uk](http://www.xmasdirect.co.uk), [www.dzd.co.uk](http://www.dzd.co.uk) & [www.sparklinglights.co.uk](http://www.sparklinglights.co.uk)

Email: [info@xmasdirect.co.uk](mailto:info@xmasdirect.co.uk) Telephone: 0333 2406120 Perth UK PH1 3WB

Imported by The Corporate Christmas Tree Company Ltd